

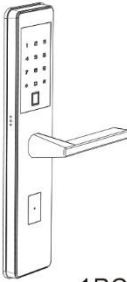









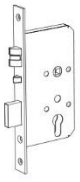



<p>A</p>  <p>1PC</p>	<p>B</p>  <p>1PC</p>	<p>C</p>  <p>1PC</p>	<p>D</p>  <p>1PC</p>	<p>E</p>  <p>1PC</p>	<p>F</p>  <p>1PC</p>	<p>G</p>  <p>2PCS</p>
<p>H</p>  <p>2PCS</p>	<p>I</p>  <p>1PC</p>	<p>J</p>  <p>2PCS</p>	<p>K</p>  <p>2PCS</p>	<p>L</p>  <p>2PCS</p>	<p>M</p>  <p>4PCS</p>	<p>N</p>  <p>4PCS</p>

STEP1



STEP2

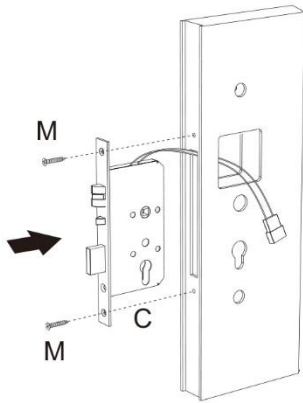
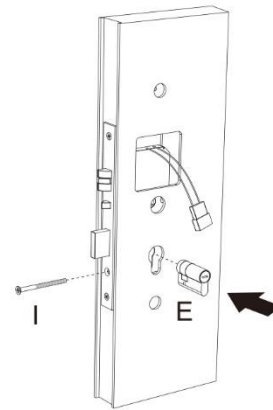

STEP3

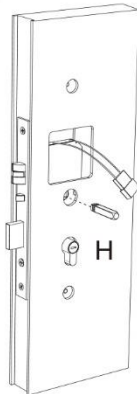

STEP4

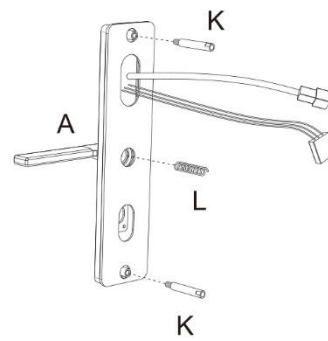

STEP5

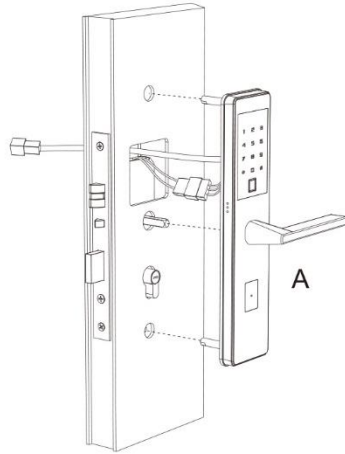

STEP6

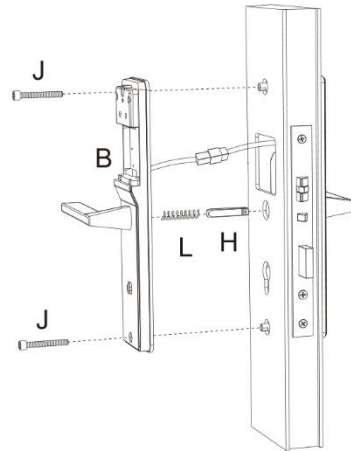

STEP7

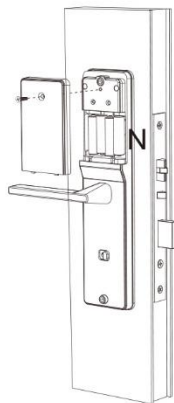

STEP8



STEP9

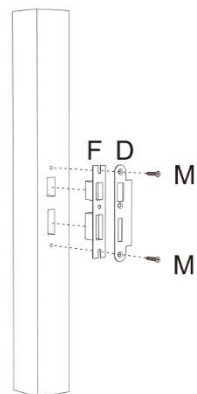

STEP10

